

GS-4000 SERIES

Ultra Performance CNC Turning Centers

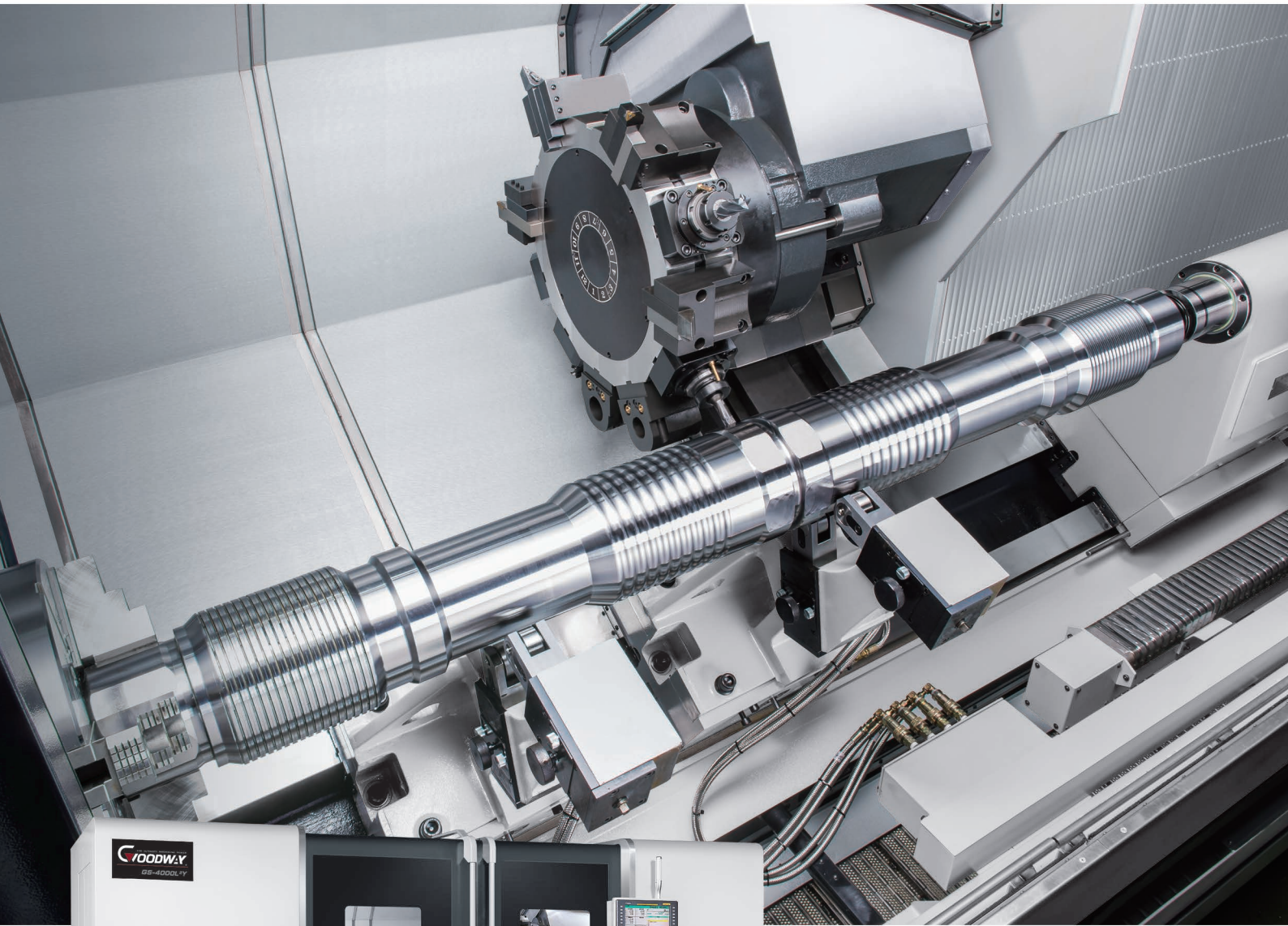

THE ULTIMATE MACHINING POWER
WOODWAY®

MAXIMUM PERFORMANCE CNC TURNING CENTERS

For those seeking a heavy-duty maximum performance turning center that's packed with the latest technologies, GOODWAY's GS-4000 series is the perfect answer. These machines offer awesome turning power, with the 2-speed gear-head spindles being standard on most models. Live tooling, Y-axis and sub-spindle models further increase machining efficiency and accuracy, while reducing manpower. Furthermore, GOODWAY machines are always fully loaded with standard features that are either not available or are costly options found on other machines. Features such as the chip conveyor, programmable base tailstock, turning tool holders, and many more standards .

► 4 bed lengths and 2 spindle sizes offer a total of 8 basic model configurations

SERIES		GS-4000 SERIES	GS-4300 SERIES
Chuck Size		Ø 15" (18")	Ø 20" (24")
Bar Capacity		Ø 115 mm (4.5")	Ø 165 mm (6.5")
Turning Length*1	750 mm (29.5")	GS-4000 / M / Y / S / MS / YS	GS-4300 / M / Y / S / MS / YS
	1,500 mm (59")	GS-4000L / LM / LY / LS / LMS / LYS	GS-4300L / LM / LY / LS / LMS / LYS
	2,250 mm (88.5")	GS-4000L ² / L ² M / L ² Y	GS-4300L ² / L ² M / L ² Y
	3,000 mm (118.1")	GS-4000L ³ / L ³ M / L ³ Y	GS-4300L ³ / L ³ M / L ³ Y

*1 Individual models may vary, detail Specification please see work range diagram.

[M] model for optional live tooling turret function. For detail Specifications, please see Page 6 & 18.

[Y] model for optional Y-axis function. For detail Specifications, please see Page 7 & 18.

[S] model for optional sub-spindle function. For detail Specifications, please see Page 8 & 18.

- Under the covers, you'll need a 30 degrees slant bed with super wide box ways, and the GS-4000 & GS-4300 series is equipped with an enormous 2-speed head stock driven by a 37 kW (30 min.) FANUC motor.
- Extra large Z-axis spindle motors provide the thrust needed to efficiently drill big diameter holes.
- Axes rapids are 24 m/min. on X and Z, which are 50 ~100 % faster than competitors.



Programmable tailstock design, both tailstock positioning and quill are programmable.

- ▶ Manual mode quill-jog function allows the quill to be inched forward, which makes it easier to insert the center into the center hole.
- ▶ Movement of the base and quill in auto mode are controlled by M-codes and thrust pressure is manually adjustable.
- ▶ Z-axis carriage automatically locks onto the tailstock base and moves it to the desired position with precision accuracy.



Less space limitations allow a larger coolant tank capacity of 670 L (L³ series) and easier maintenance access.

- ▶ The Coolant tank allows the connection of compressed air to circulate coolant and keep it fresh when the machine is not in use.



Separate coolant tank & Oil skimmer shown



(GS-4000L³ model shown with optional accessories)

SUPER HEAVY-DUTY CONSTRUCTION

- ▶ With its low center of gravity, the heavy-duty bed and 30° slant bed design provides a super rigid foundation for the headstock, turret, and tailstock. This creates the rigidity needed to perform super heavy-duty turning and maintain long-term high precision accuracy.
- ▶ Built to endure years and years of rigorous high production turning, the heavily ribbed, one-piece thermally balanced bed and casting components are made up of FC35 MEEHANITE casting (industry standard is FC25~30). FC35 grade cast iron is capable of withstanding much greater stress without deformation and provides maximum vibration damping, resulting in a machine that will outlast and outperform competition.
- ▶ By using Finite Element Analysis (FEA), optimally reinforced ribbings are directly casted into the one-piece bed structure. Mechanical rigidity has been increased by more than 30% when compared to conventional designs.

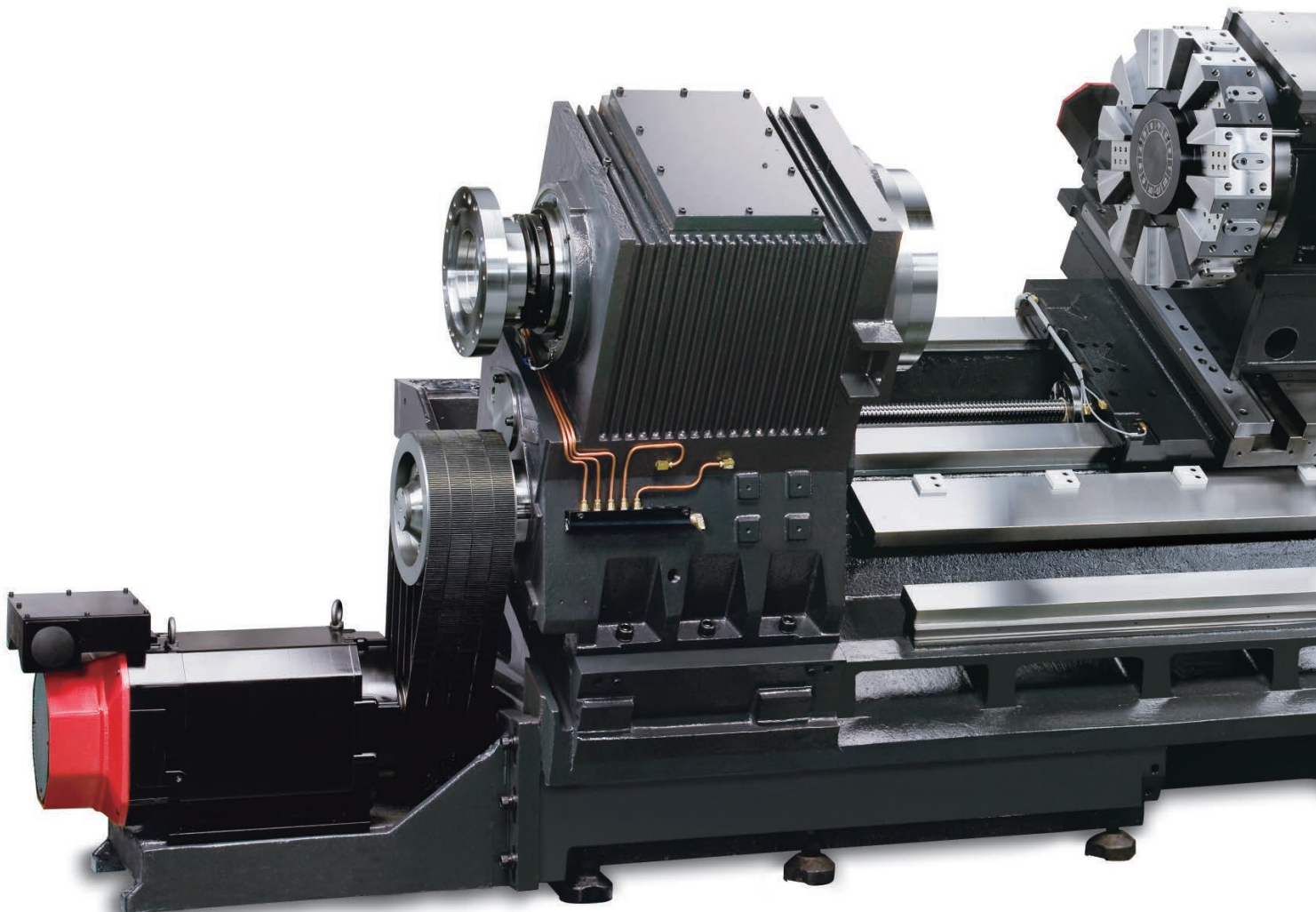
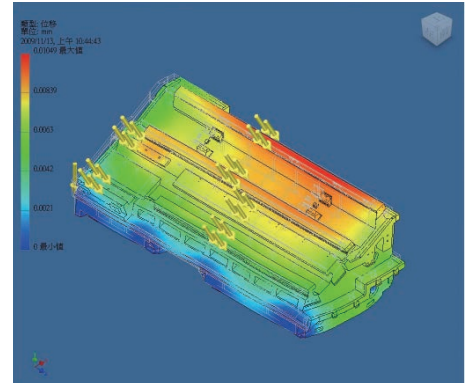

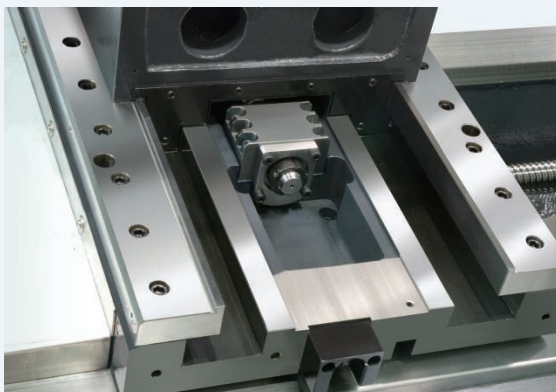

- ▶ Extra wide hardened and ground box ways are directly formed into the machine bed and saddle during the casting process. They are precision machined and widely spaced for maximum strength. The box way design also provides the rigidity needed for heavy duty and interrupted turning applications.
- ▶ C3 class hardened and precision ground ball screws ensure the highest accuracy and durability possible. Plus, pretension on all axes minimizes thermal distortion.
- ▶ The L³ series Z-axis, equipped with independent supporting mechanism, prevents long-sized ball screws from deforming and ensures excellent performance for the axial feed and turning accuracy.



- ▶ Contact surfaces of all slides, headstock, turret, tailstock, and ball screw bearing housings with the machine bed are hand scraped to provide maximum assembly precision, structural rigidity, and load distribution.

(Casting structure of GS-4000L model shown)

ULTIMATE TURNING POWER

- ▶ The heavy-duty headstock is made up of one-piece casting, reinforced with heat dispending fins.
- ▶ P4 grade (Class 7) super-high precision bearings are directly assembled for maximum level of support and precision. Bearing configuration is designed for super heavy-duty cutting with ultra-smooth performance, long term durability and a high level of accuracy.

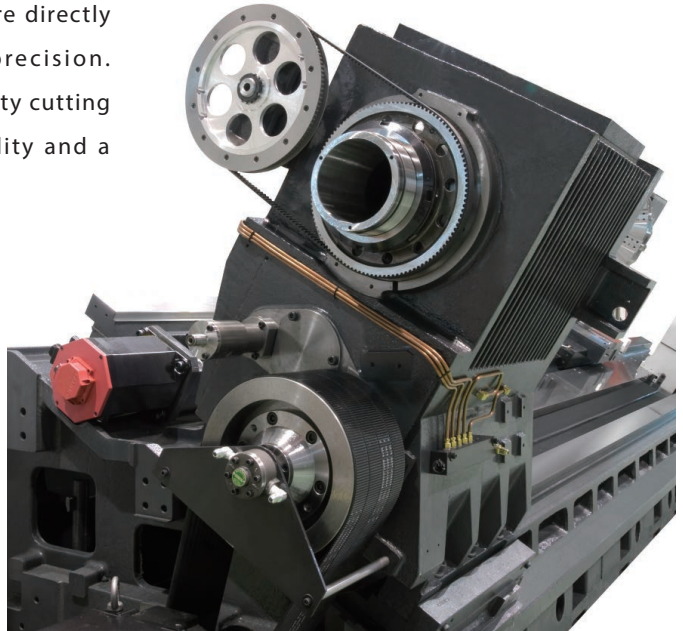
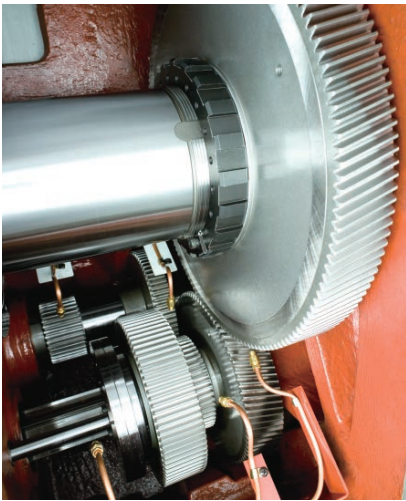

- ▶ The 2-speed, super heavy-duty gear head incorporates advanced mechanical designs. Mated with a 37 kW (30 min.), a tremendous amount of low-end torque is provided to handle heavy material removal on large diameter parts.

Spindle Output

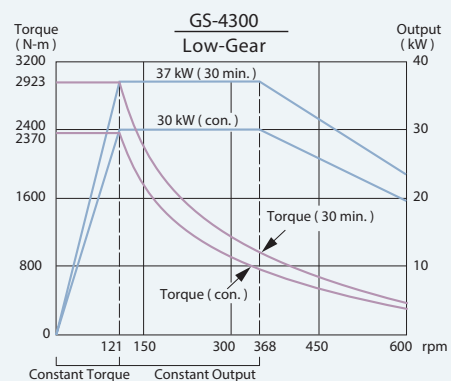
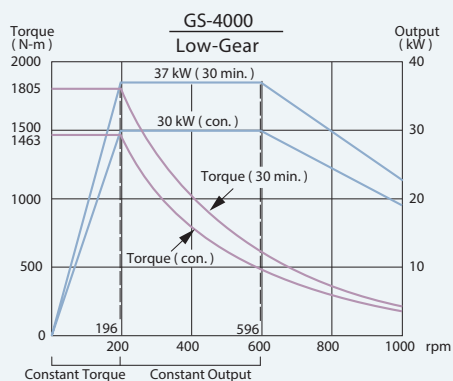
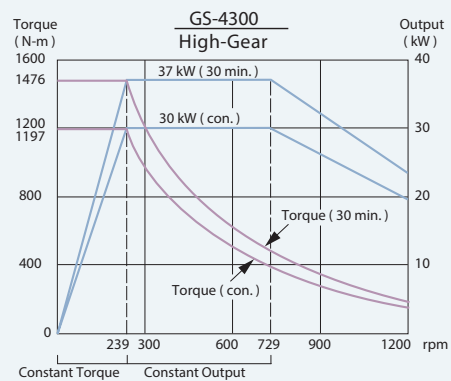
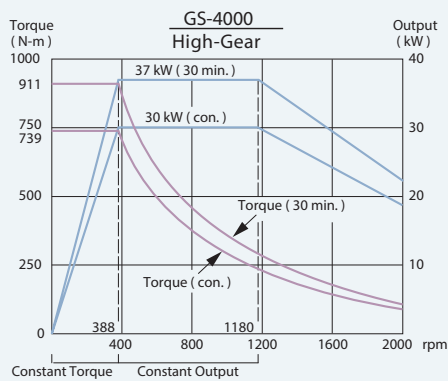

ADVANCED TURRET TECHNOLOGY

- ▶ Ø 320 mm diameter super high precision CURVIC couplings accurately position the turret disk and 6,400 kg of clamping force ensure abundant turret rigidity for all cutting conditions.
- ▶ The 12-station heavy-duty servo indexing turret achieves 0.3 second indexing times for adjacent stations. Index movements are continuous, without pauses, and is capable of turning Ø 268 mm (Ø 10.5") diameter work-pieces without interference when using boring tools. The optional 10-station turret even clears a diameter up to Ø 331 mm (Ø 13").

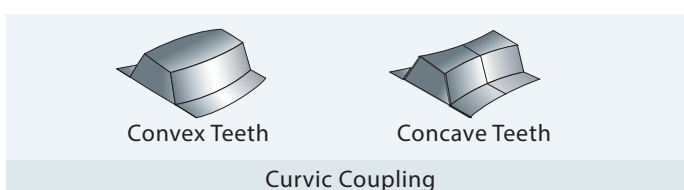

- ▶ The curvic couplings provide a large contact area and are designed with an auto-clean feature not seen on traditional couplings.

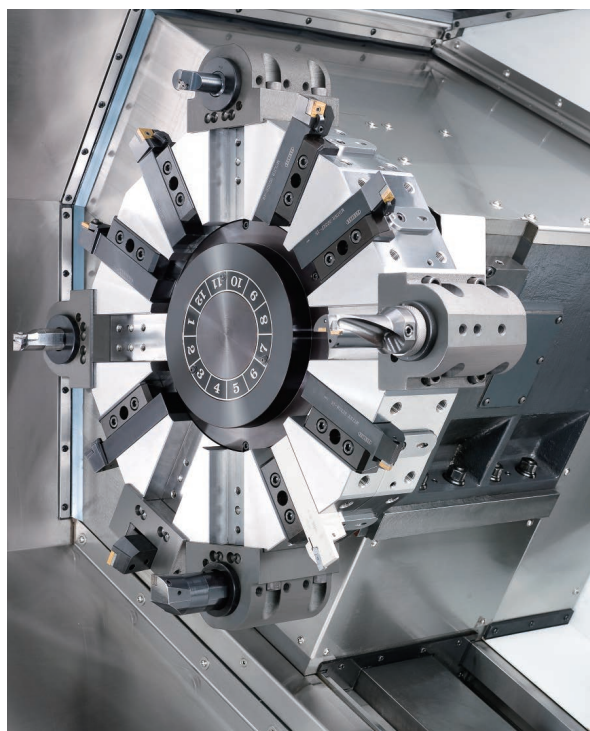

LIVE TOOLING TURRET

- ▶ Live tooling and C-axis control capabilities on the GS-4000 series allow the machine to perform multiple tasks on a work-piece, such as turning, milling, drilling, and tapping. It eliminates manpower and cycle time while reducing in loss of accuracy, which will occur if the part is moved from machine to machine.
- ▶ The GS-4000 series live tooling turret is driven by a large 7.5 kW (30 min.) motor. Combined with a powerful gear driven spindle, it provides ultra-high power to complete any difficult milling, drilling, and tapping applications.
- ▶ The 12-station GOODWAY live tooling turret offers 12 stations available for live tooling, and the live tools only rotate in working position in order to reduce power loss and heat.

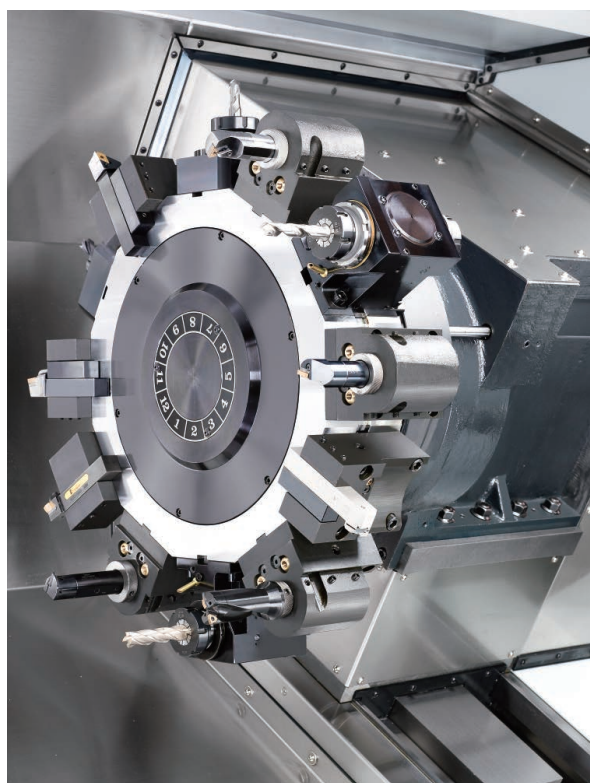

- ▶ The Cs-axis is adopted with a high-resolution toroid along with a full-closed loop design to provide excellent positioning accuracy and repeatability.

Y-AXIS MACHINING CAPABILITY

- ▶ The Y-axis control further enhances multi-tasking live tooling capabilities and improves various machining precision. High precision grooving and X-axis off-center drilling are enabled.
- ▶ On Y-axis equipped machines, the turret is mounted on a secondary 30 degrees wedge saddle on top of the X-axis slide. Both X and Y axes have extra wide hardened and ground box way that are directly formed onto the saddles during the casting process. They are precision machined and widely spaced for maximum strength.
- ▶ With an abundant amount of Y-axis travel, 120 mm = ± 60 mm (4.72" = ± 2.36"), a wide variety of parts may be efficiently machined.

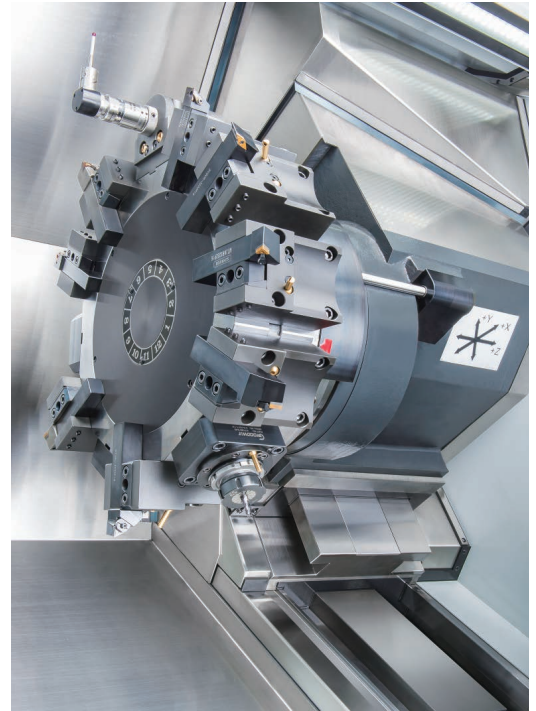

- ▶ Live tooling turret for Y-axis machine is equipped with 5.5 kW output, high precision built-in spindle turret.

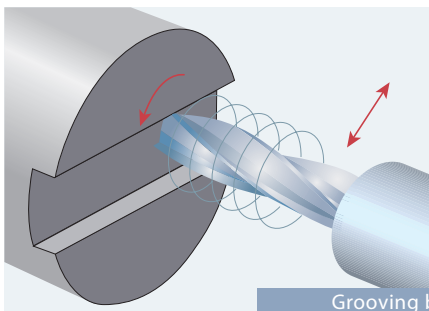

Grooving by Polar Coordinate Interpolation

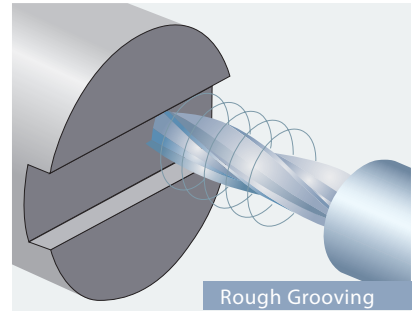
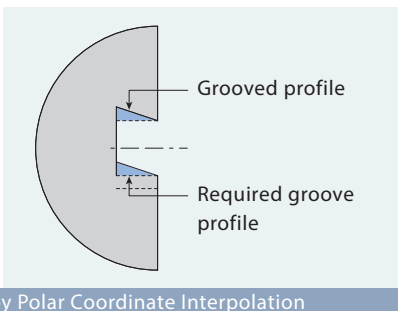

Rough Grooving

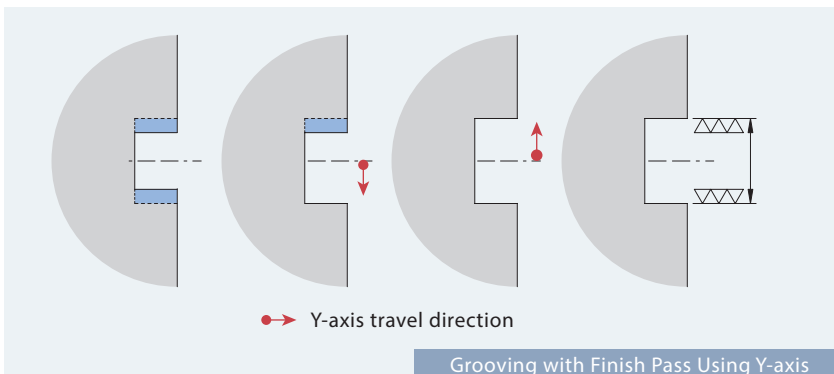

Grooving with Finish Pass Using Y-axis

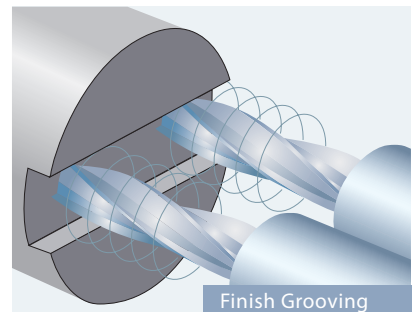

Finish Grooving

- ▶ Grooving with Y-axis control produces grooves with higher accuracy.

BACK-END MACHINING CAPABILITY

- ▶ An 8" chuck size sub-spindle, driven by a powerful 18.5 kW (15 min.) built-in type FANUC motor (Integrated Motor), is available on the GS-4000 series for back-end machining.
- ▶ The sub-spindle travels on the B-axis are used with Japanese, high precision, roller linear guideways to increase the feed rate and reduce processing time.

Sub-spindle Output

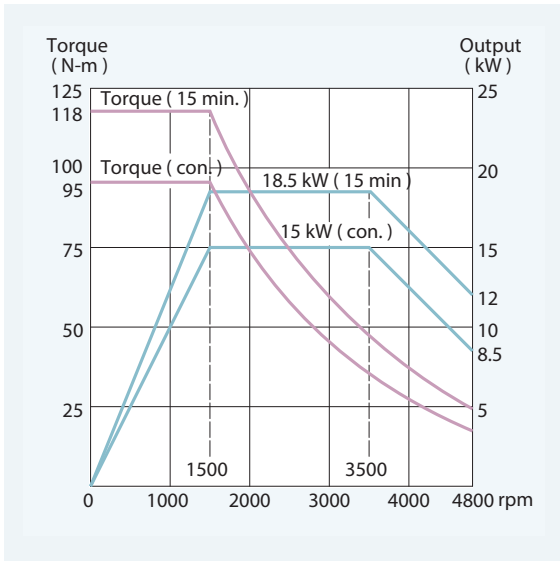

- ▶ Automatic part transfer of work piece from main spindle to sub-spindle saves manpower and cycle time, while reducing accuracy lost, which will occur if manually handling the part from machine to machine.

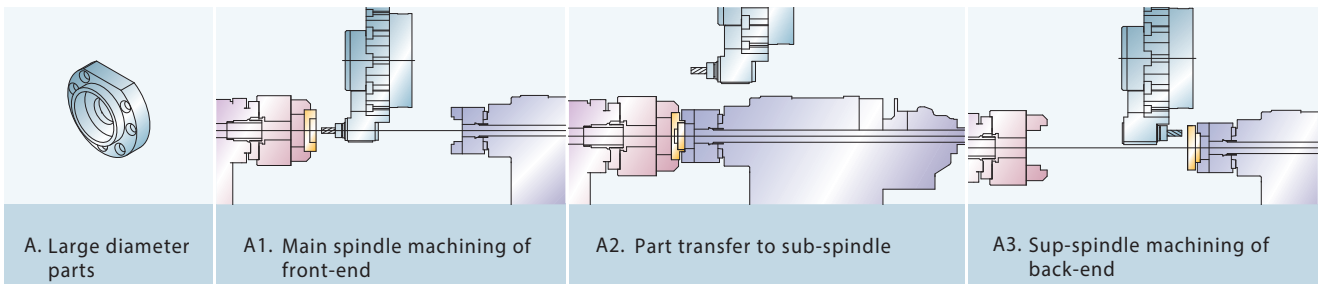

- ▶ With $\varnothing 45$ mm (1.77") bar capacity, the sub-spindle configuration is also ideal for machining long work pieces such as small diameter shafts. Both ends of the work piece can be supported by the main and sub spindles, allowing the middle section(s) to be accurately machined.

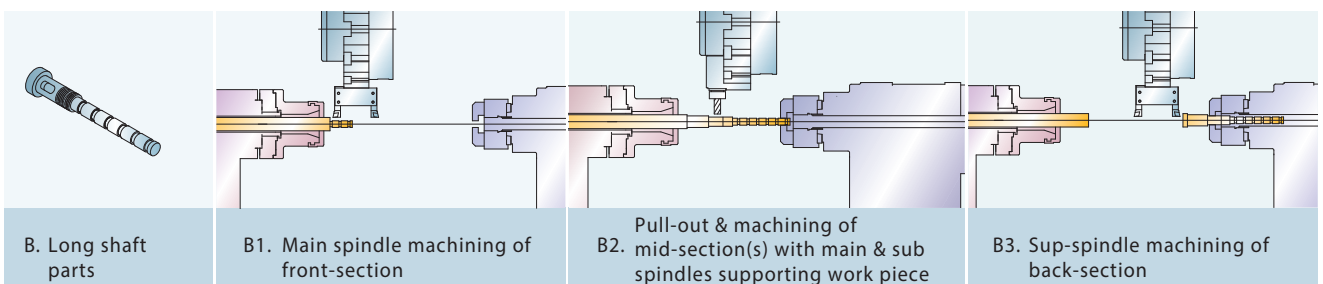

MACHINING PERFORMANCE

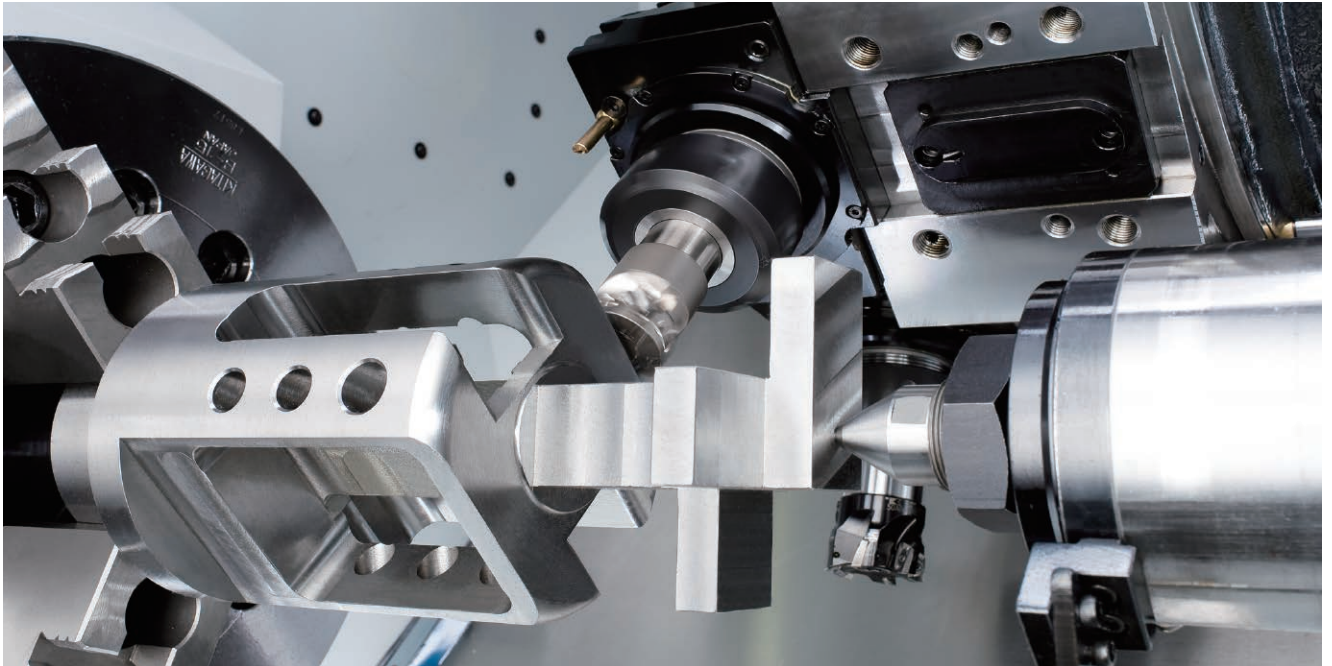

Turning Capability

Test Model	Work-piece		Cutting condition				Power requirement
GS-4000	Material	Diameter (mm)	Spindle Speed (rpm)	Cutting Speed (m/min)	Cutting Depth (mm)	Feedrate (mm/rev)	Spindle Load (%)
Heavy Cutting	S45C	Ø 175	310	170	10	0.6	102/70
Drill	S45C	Ø 58	741	135	—	0.18	62/85

Machining Capability

Test Model	Work-piece		Cutting condition				Power requirement
GS-4000M	Material	Diameter (mm)	Spindle Speed (rpm)	Cutting Speed (m/min)	Cutting Depth (mm)	Feedrate (mm/rev)	Spindle Load (%)
Drill	S45C	Ø 25	249	20	—	90	—
End Mill	S45C	Ø 25	510	40	15	290	—

Live Tooling Turret Output

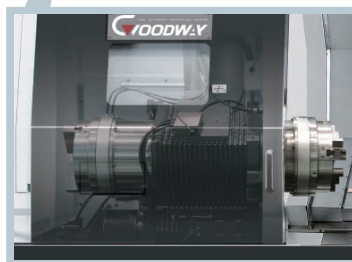
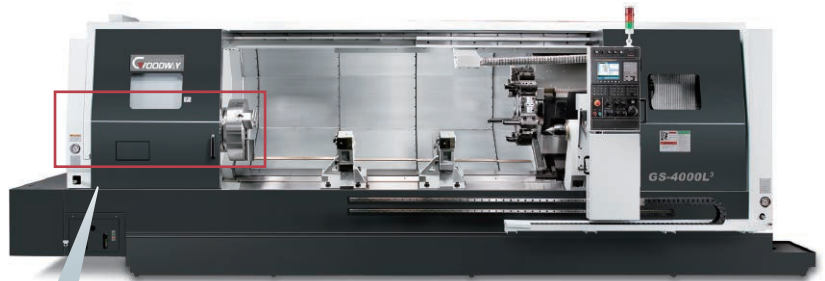
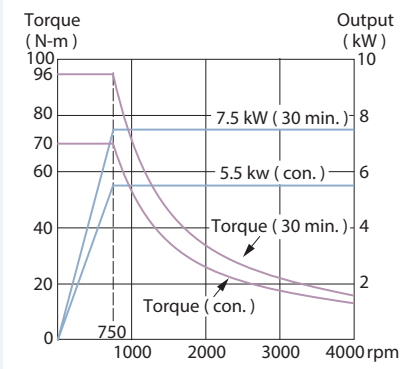

Dual-chucks (Optional)

- The front-end of the spindle can be installed with an air chuck or a manual chuck to easily apply operations such as thread cutting and machining long work-pieces.

Standard 12-Stations Turret

Interference Diagram

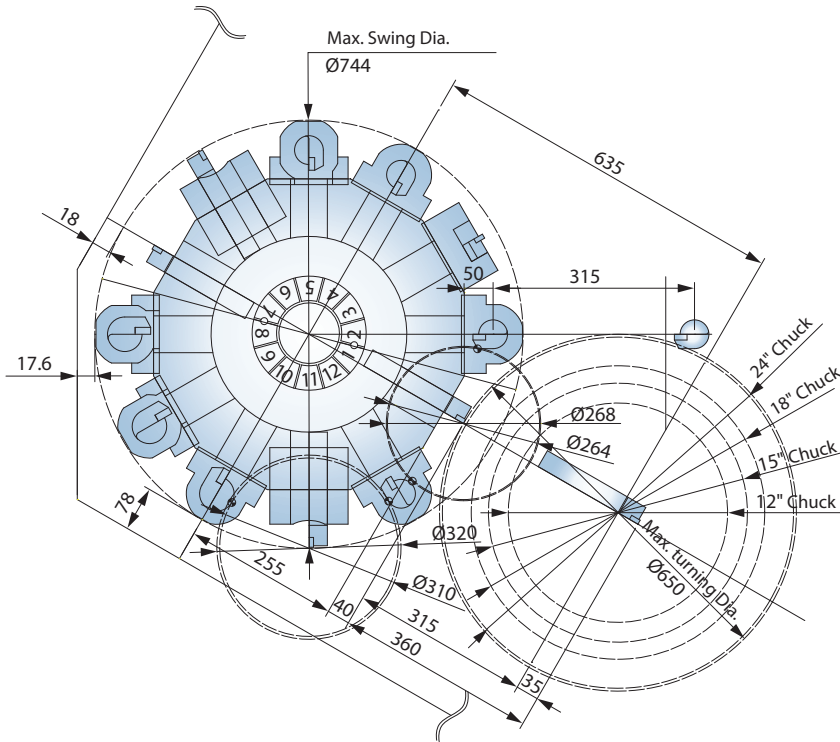

Optional 12-Stations Live Tooling Turret

Interference Diagram

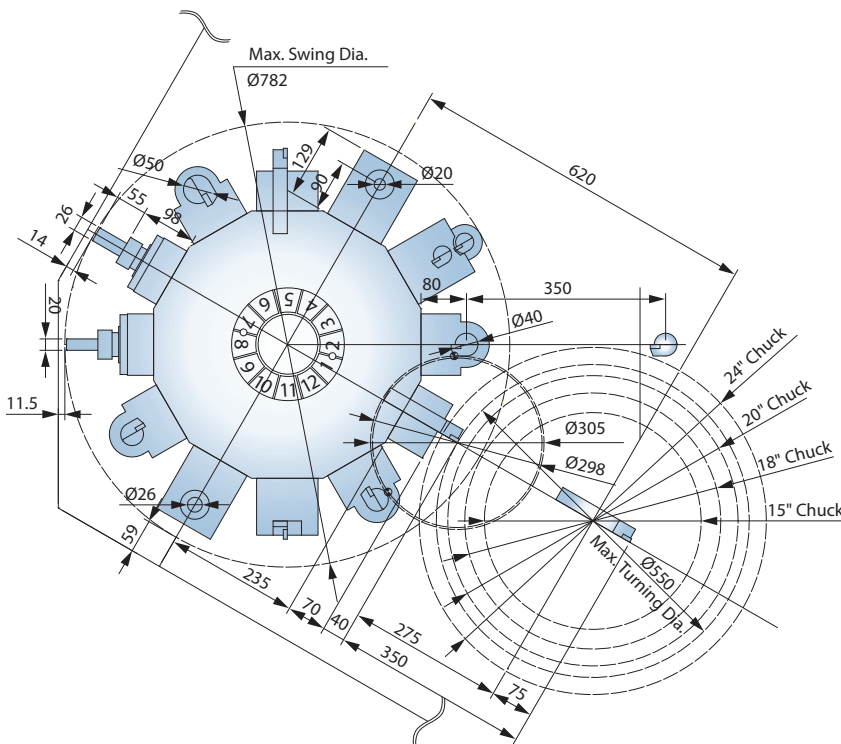

Unit : mm

Tooling System

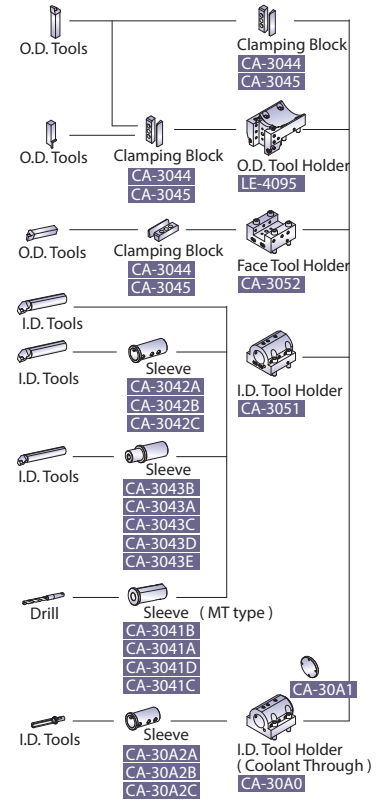

Tooling System

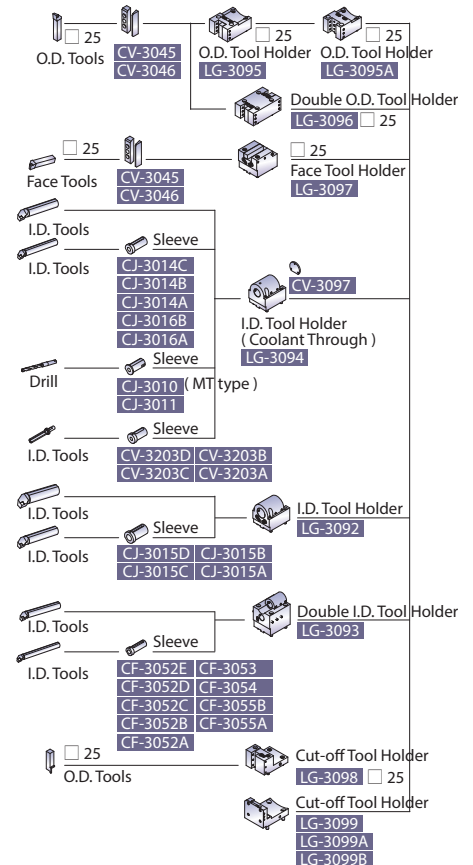

Optional Y-axis

Interference Diagram

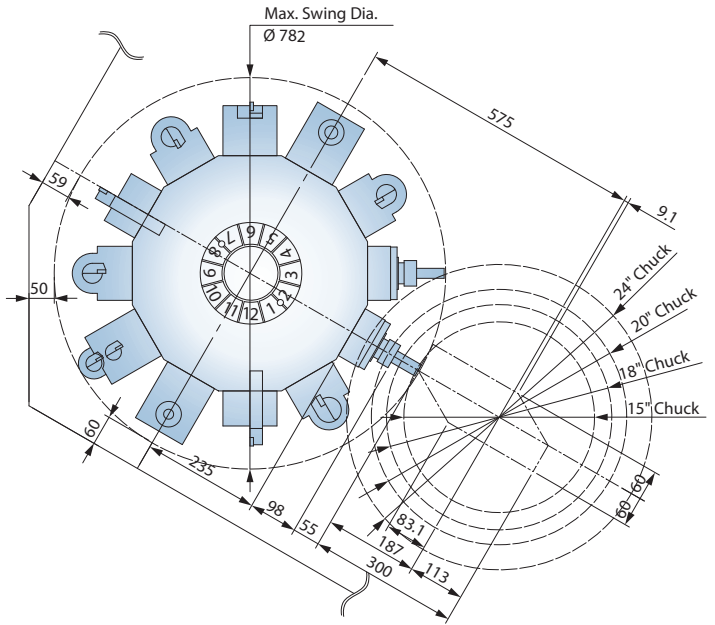
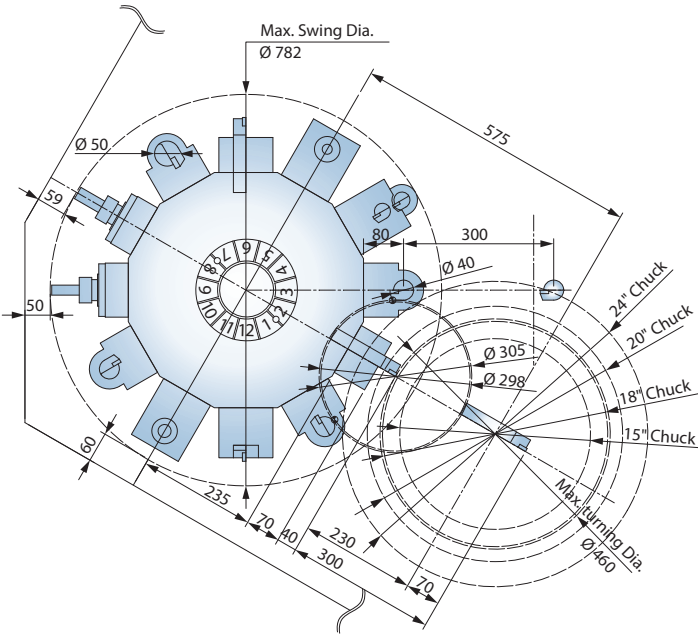

Interference Diagram

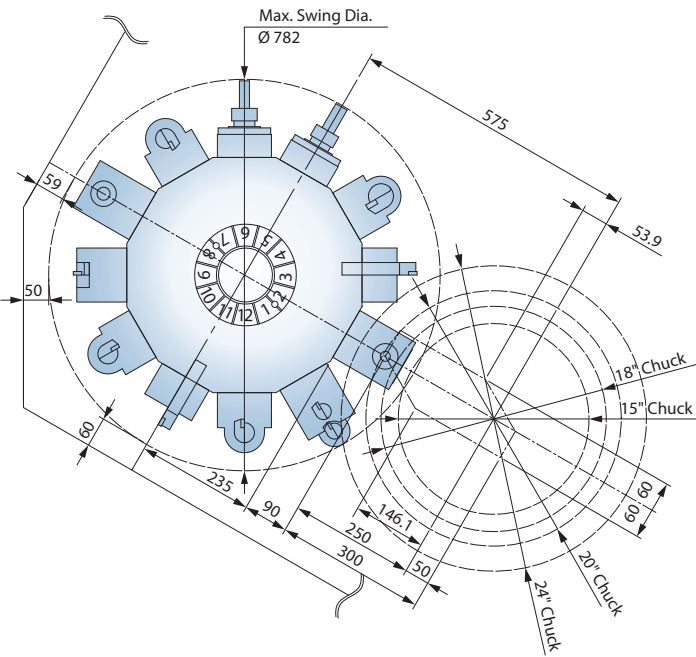

Tooling System

O.D. Tools	CV-3045 CV-3046	O.D. Tool Holder	LG-3095	O.D. Tool Holder	LG-3095A
		Double O.D. Tool Holder	LG-3096		25
Face Tools	CV-3045 CV-3046	Face Tool Holder	LG-3097		25
I.D. Tools		Sleeve			
I.D. Tools	CJ-3014C CJ-3014B CJ-3014A CJ-3016B CJ-3016A	I.D. Tool Holder (Coolant Through)	LG-3094		CV-3097
Drill	CJ-3010 (MT type) CJ-3011	Sleeve			
I.D. Tools	CV-3203D CV-3203C	CV-3203B CV-3203A			
I.D. Tools		Sleeve		I.D. Tool Holder	LG-3092
I.D. Tools	CJ-3015D CJ-3015C	CJ-3015B CJ-3015A			
I.D. Tools		Sleeve		Double I.D. Tool Holder	LG-3093
I.D. Tools	CF-3052E CF-3052D CF-3052C CF-3052B	CF-3053 CF-3054 CF-3055B CF-3055A			
O.D. Tools				Cut-off Tool Holder	LG-3098
				Cut-off Tool Holder	LG-3099 LG-3099A LG-3099B

Unit : mm

Standard 12-Stations Turret

[Work Range]

MT#6 Live Center

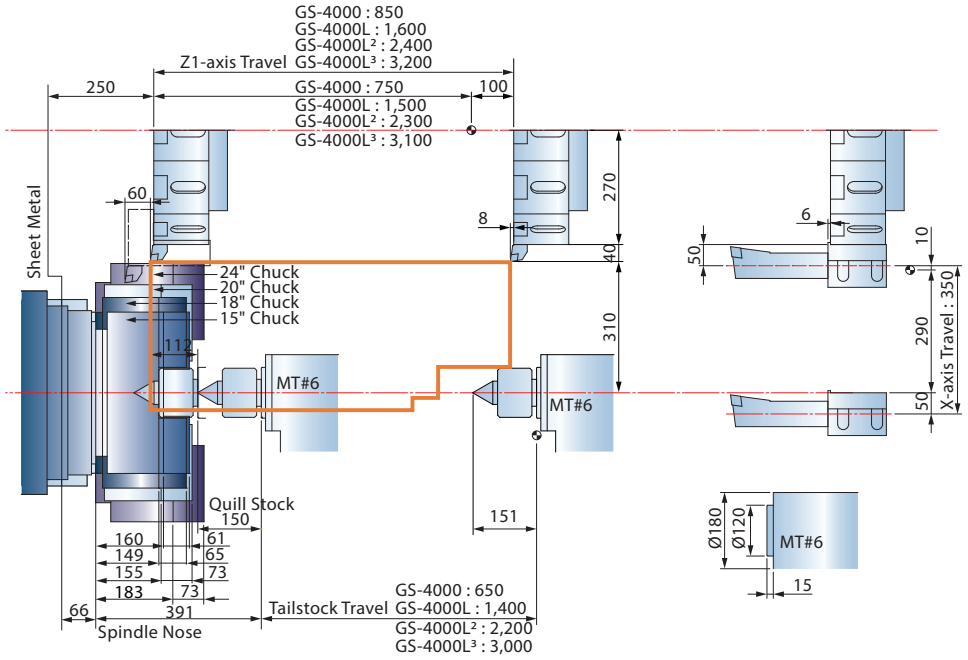

11

12

Optional Live Tooling Turret

[Work Range]

MT#6 Live Center
(I.D. / O.D. Tools)

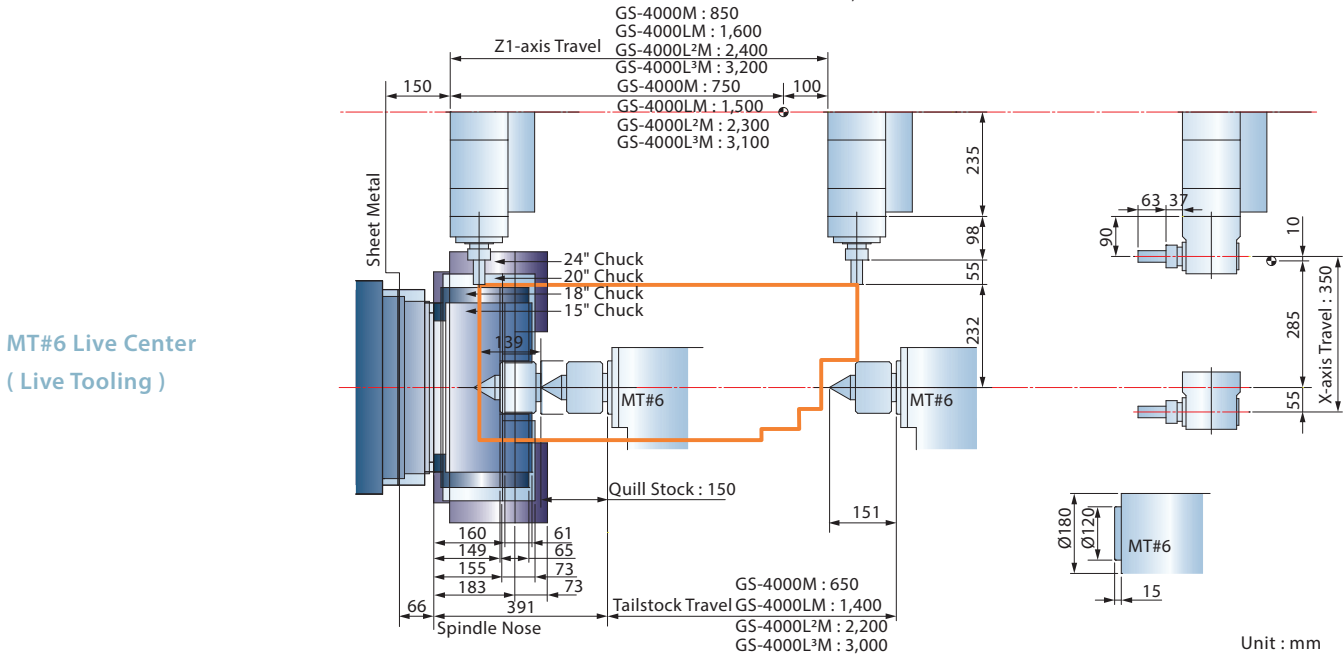
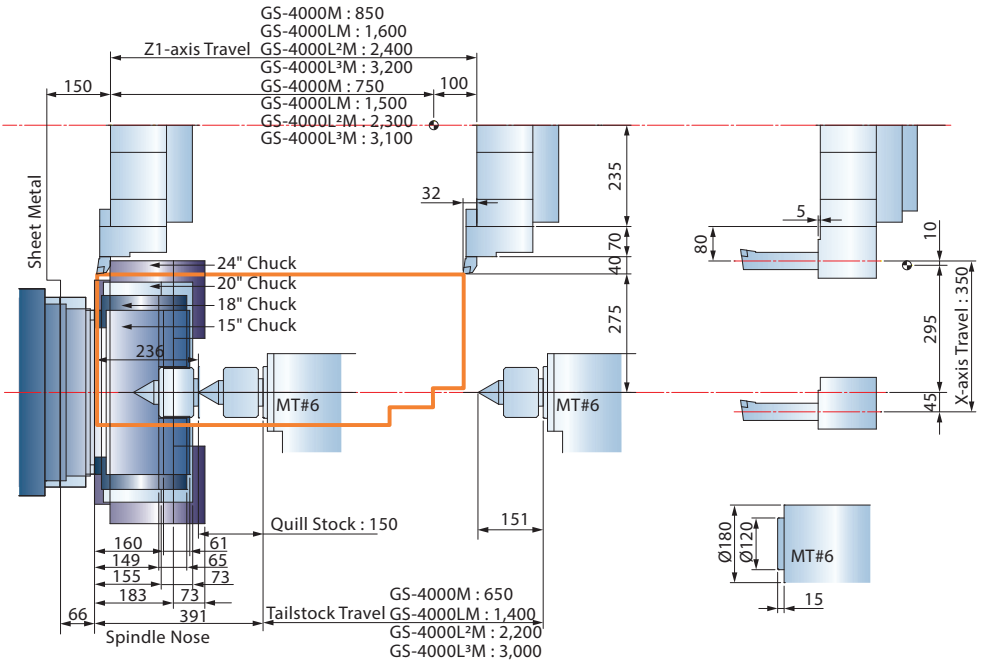

MT#6 Live Center
(Live Tooling)

Unit : mm

Optional Live Tooling Turret & Sub-spindle

[Work Range]

(I.D. / O.D. Tools)

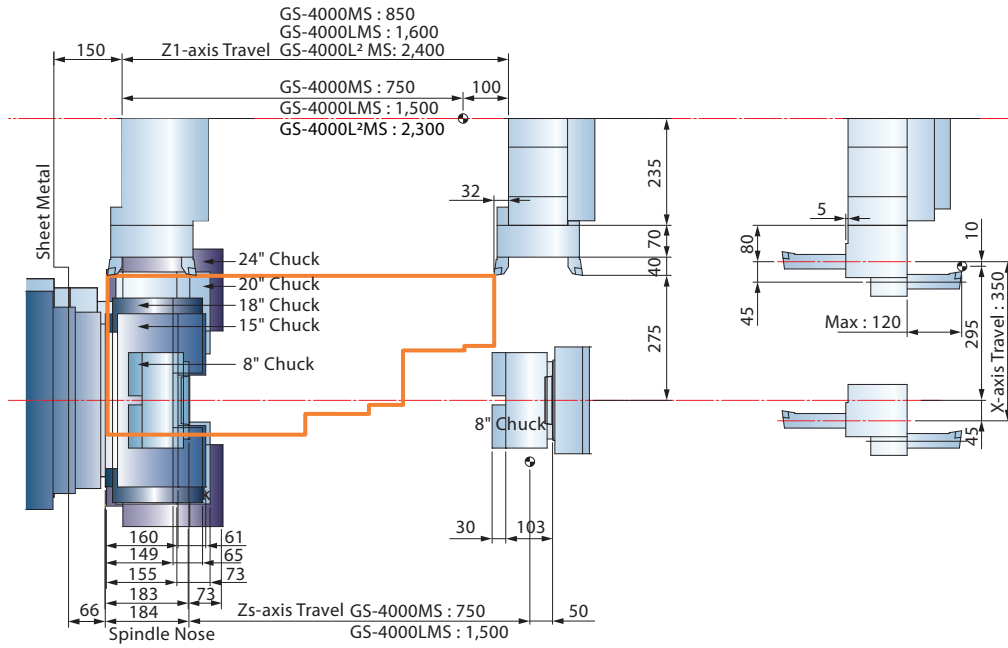

(Live Tooling)

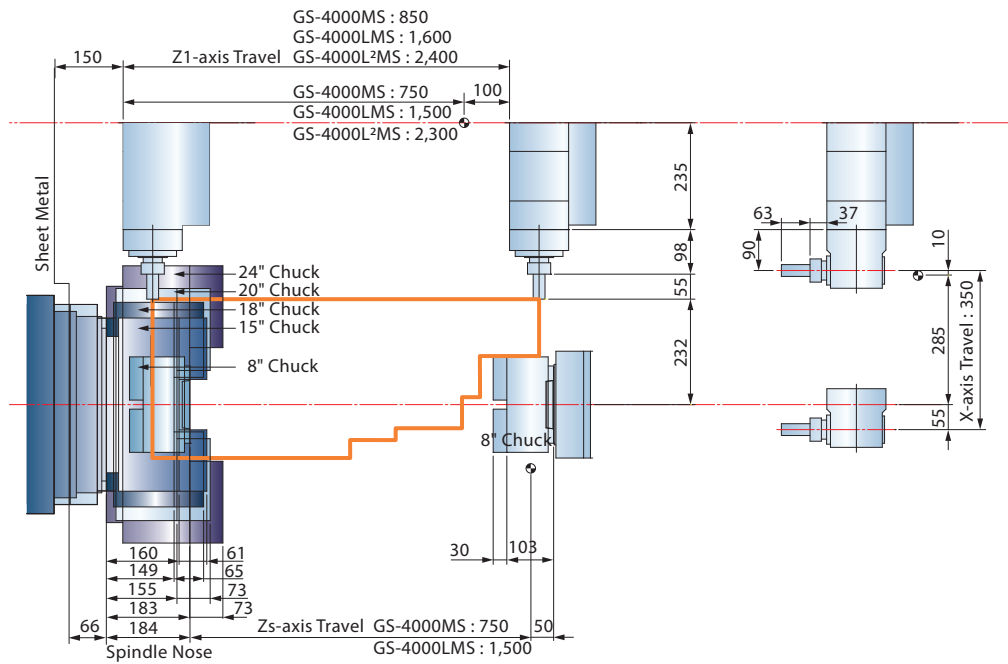

(I.D. / O.D. Tools)

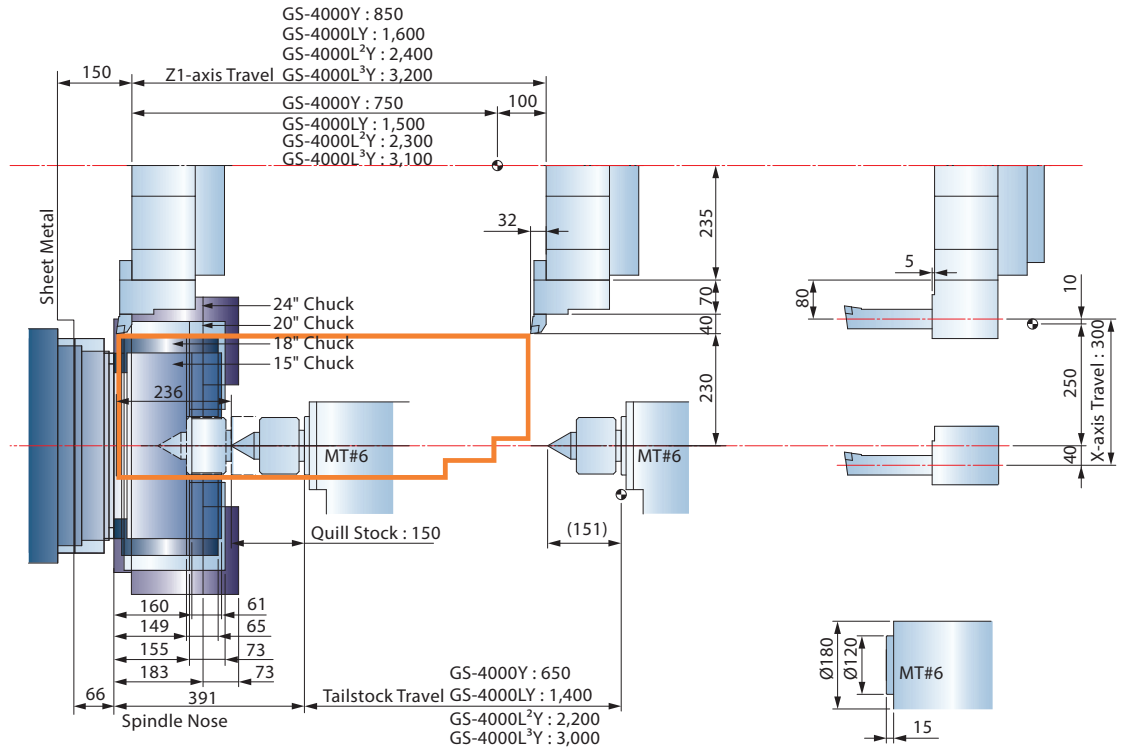

(Live Tooling)

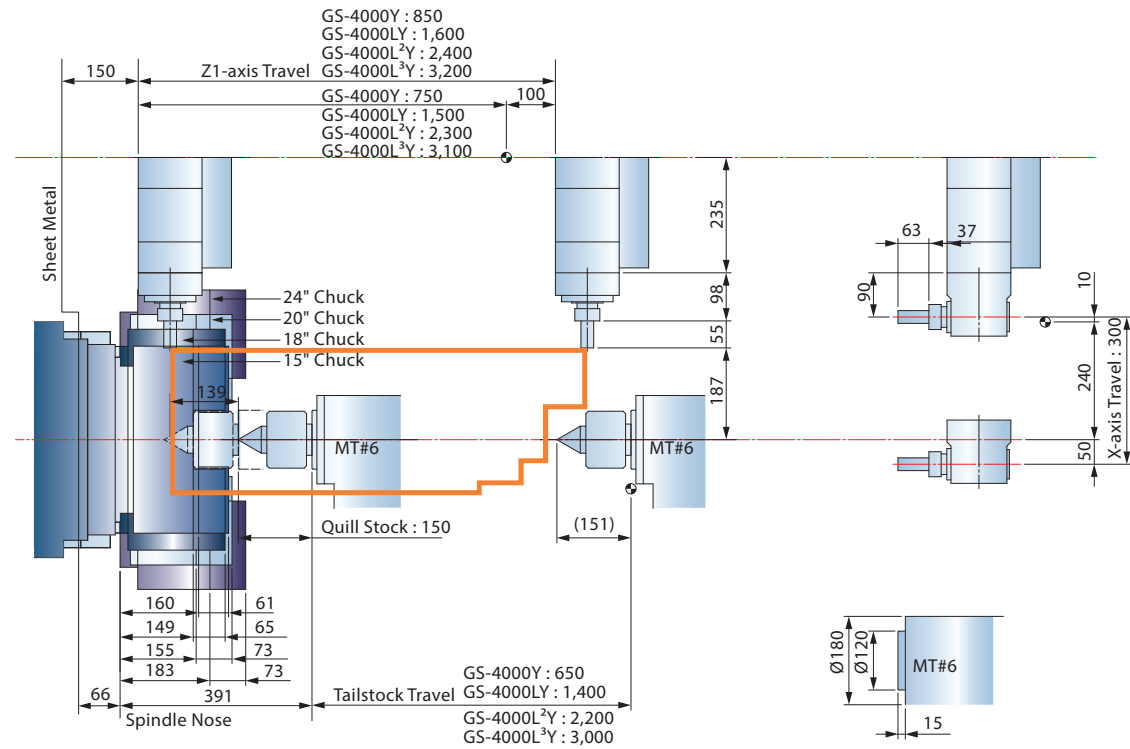

Optional Y-axis & Sub-spindle

[Work Range]

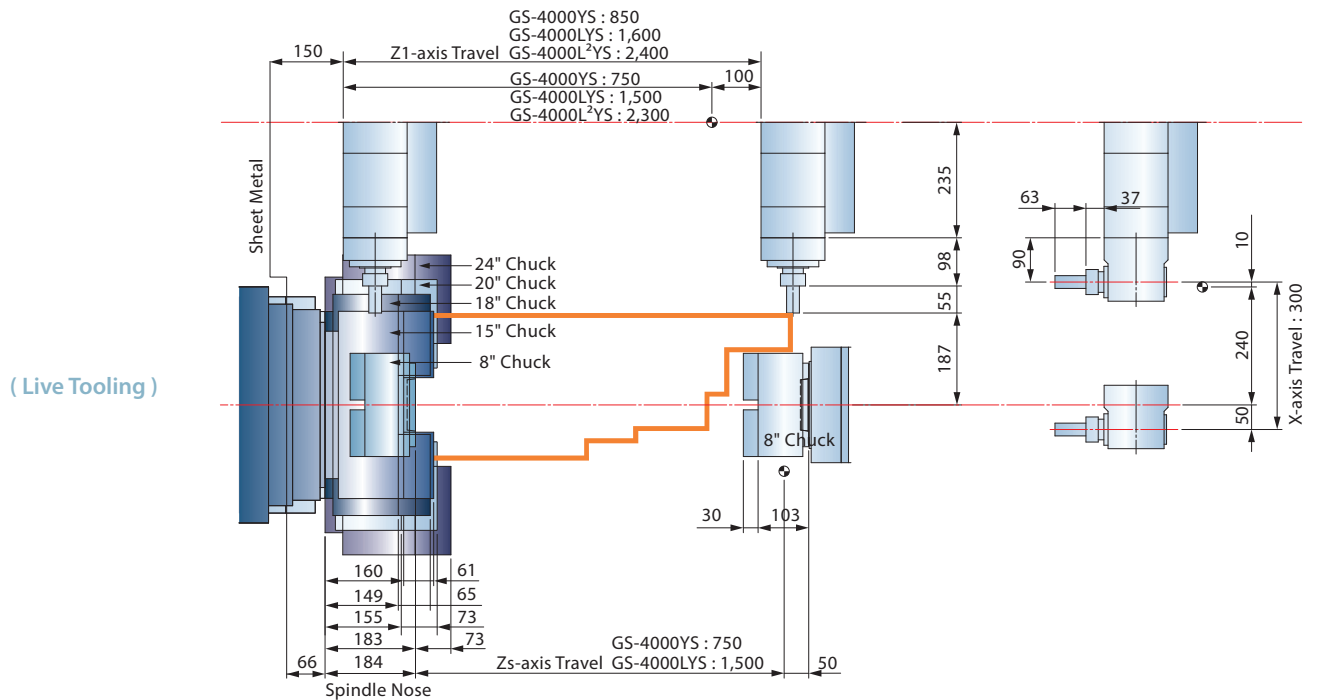
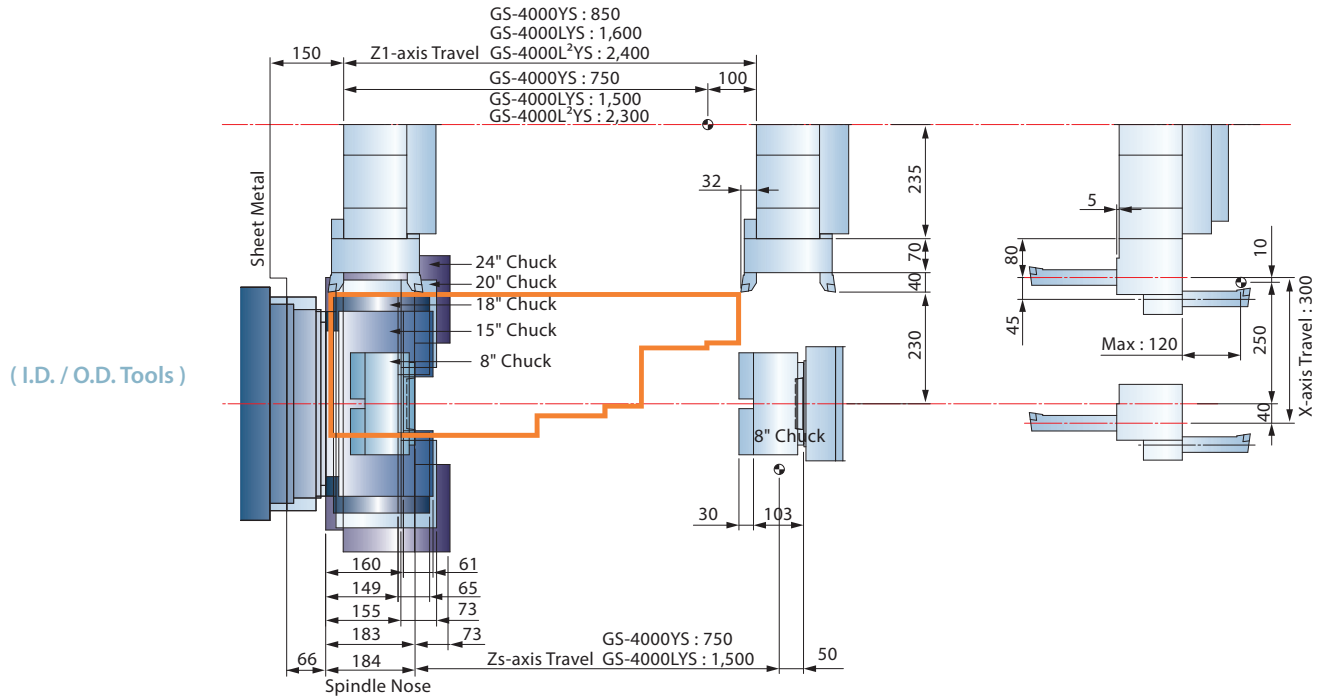

Unit : mm

GENERAL DIMENSION

Space Requirement

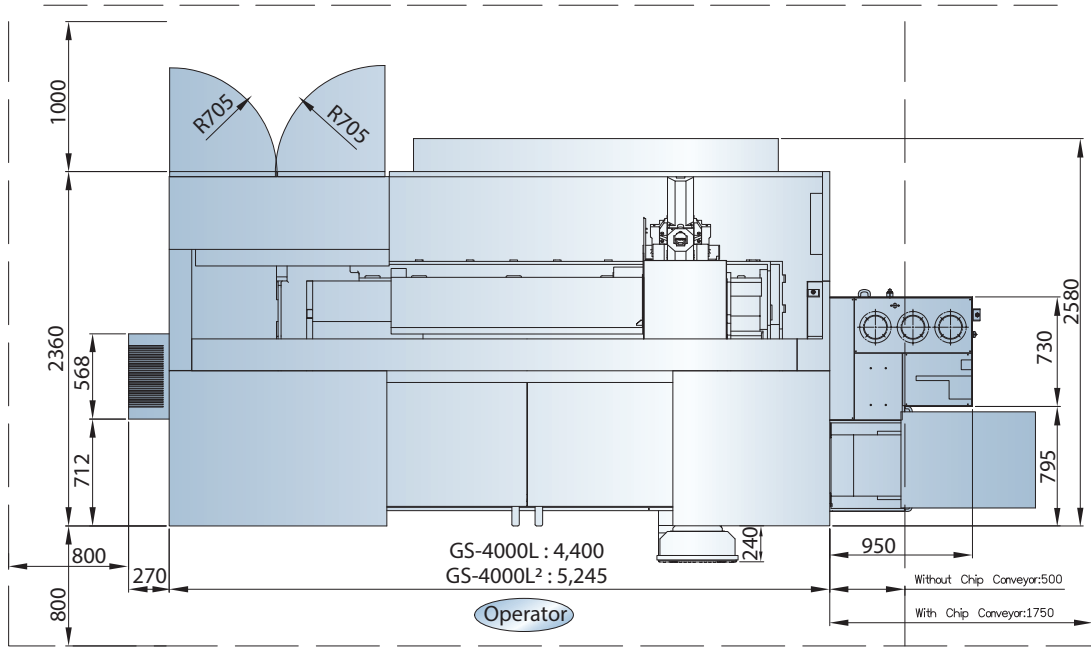

ut

Foundation Requirement

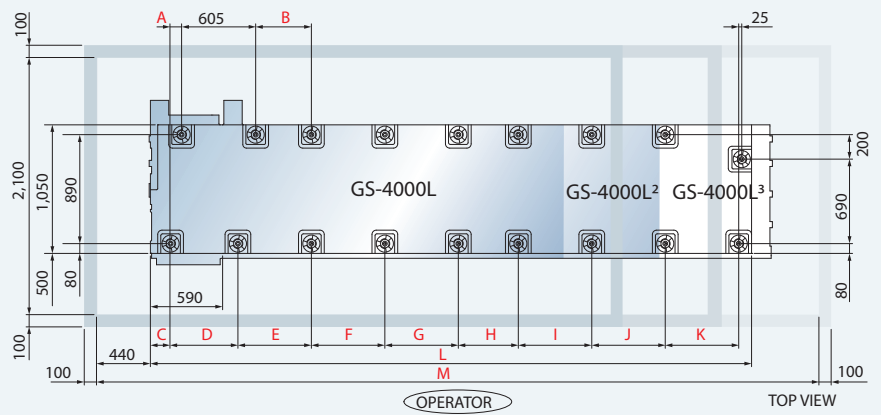
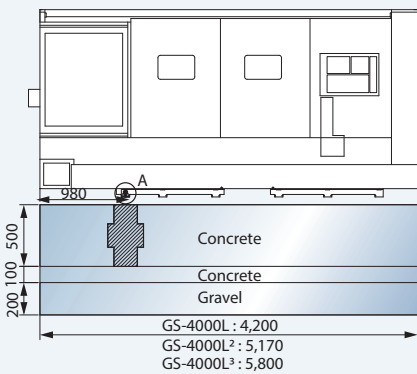

Unit : mm

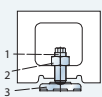

N0.	Part No	Part Name
1	CA-1029	Levelling Bolt
2	NA3900BA	Hex. Nut M39
3	CA-1030	Leveling Block

Model	A	B	C	D	E	F	G	H	I	J	K	L	M
GS-4000L	90	455	165	550	600	600	600	600	—	—	—	3,220	4,200
GS-4000L²	90	505	165	600	600	647	647	646	700	—	—	4,110	5,170
GS-4000L³	95	455	160	550	600	600	600	490	600	600	600	4,910	5,800

STANDARD FEATURES

3-Jaw Chuck w/ Soft Jaws x 1 set

- ▶ Standard 3-jaw hydraulic chuck with soft jaws is able to work with various types of work-pieces.



Heat Exchanger

- ▶ The heat exchanger provides the electrical box with good air circulation to efficiently lower the interior temperature and stabilize the electrical devices.



Lubrication System

- ▶ The lubrication unit monitors preset pressure levels detect leaks in the system.
- ▶ Copper lubrication lines will not corrode or become brittle over time.

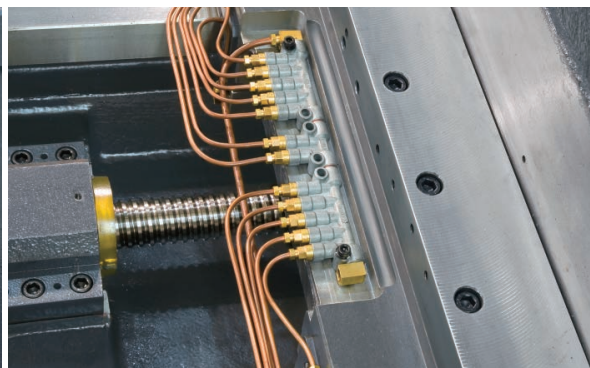
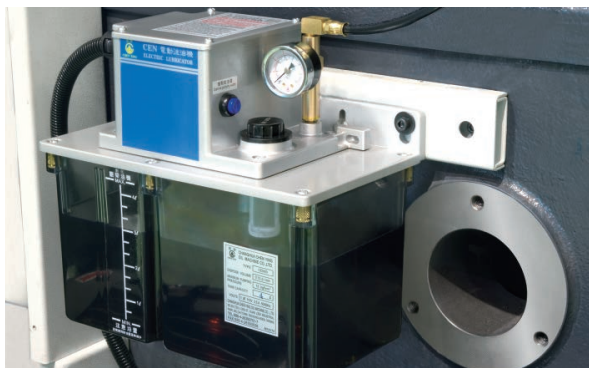

Chip Conveyor

- ▶ The standard chip conveyor features adjustable timers that allow the operator to set operation intervals according to the amount of chips generated by the machine. As a result, coolant loss is reduced to a minimum.



Tri-color Status Light

- ▶ The tri-color status light enables the machine's status to be checked without having to stand at the control panel, and the screen and work lights are shut off to conserve power.



OPTIONAL FEATURES

Bar Feeder

- ▶ The optional bar feeding systems feed bars with a diameter up to Ø105 mm, and the BF-65 can handle bar diameters of up to Ø 65 mm.



Tool Setter

- ▶ The optional Renishaw HPRA tool presetter simplifies the machining setup.

The steady rest is applied to long work-pieces that can be rmly supported to increase turning accuracy.

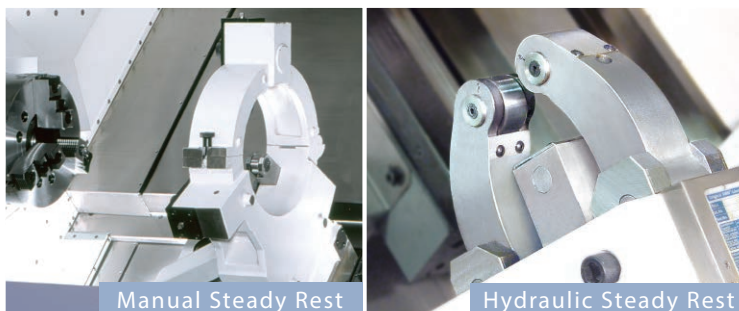

Manual Steady Rest

Hydraulic Steady Rest

Manual Steady Rest

- ▶ It can be manually adjusted and requires less space than hydraulic steady rests.

Hydraulic Steady Rest

- ▶ The hydraulic pressure is controlled by the program to increase working efficiency.

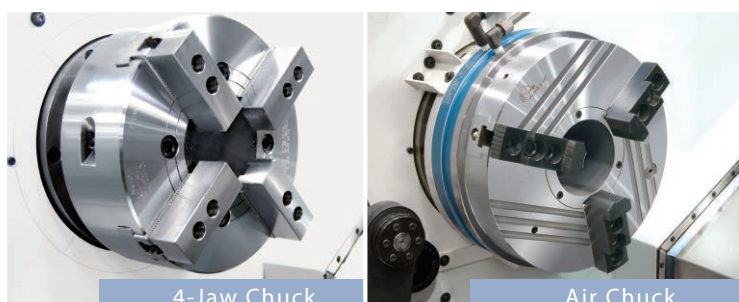

4-Jaw Chuck

Air Chuck

4-Jaw Chuck

- ▶ The 4-jaw chuck can work with complex-shaped or non-circular materials that cannot be done by 3-jaw chucks.

Air Chuck

- ▶ As opposed to a hydraulic chuck, the air chuck can work with soft or thin material to prevent deformation.

STANDARD & OPTIONAL FEATURES

S: Standard O: Optional
 -: Not Available C: Contact GOODWAY

		GS-4000	GS-4300
SPINDLE			
Main spindle motor configuration	2-Speed Gear	S	S
Rigid tapping & spindle orientation		S	S
Disk brake for main		O	O
Sub-spindle & 8" hydraulic cylinder ^{*1}		O	O
Cs-axis & disk brake for Sub-spindle ^{*1}		O	O
WORK HOLDING			
Hydraulic hollow cylinder for chuck	118 mm ID.	S	S
	180 mm ID.	O	O
	15"	S	-
	18"	O	-
	20"	-	S
Hollow 3-jaws chuck & 1 set soft jaws	24"	-	O
Hard jaws		O	O
Special work holding chuck		C	C
In spindle work stopper		O	O
Spindle liner (guide bushing)		O	O
Foot switch for chuck operation		S	S
Programmable base & quill hydraulic tailstock		S	S
MT#4 dead center* (servo tailstock)		O	O
MT#5 live center* (servo tailstock)		O	O
MT#6 live center		S	S
Manual steady rest		O	O
Self-centering hydraulic steady rest		O	O
Foot switch for steady rest operation		O	O
Two-stage programmable pressure	Chuck damping	O	O
	Tailstock thrust	O	O
TURRET			
10-station turret		O	O
12-station turret		S	S
12-station live tooling turret		O	O
Tool holder & sleeve package		S	S
Live tooling tool holders (0°x2, 90°x2)		O	O
MEASUREMENT			
Renishaw HPRA tool presetter	Removeable	O	O
COOLANT			
Coolant pump	3 Kg/cm ²	S	S
	5 Kg/cm ²	O	O
High-pressure coolant system	20 Kg/cm ²	C	C
Roll-out coolant tank		S	S
Oil skimmer		O	O
Coolant flow switch		O	O
Coolant level switch		O	O
Coolant intercooler system		O	O
CHIP DISPOSAL			
Chip conveyor with auto timer	Right discharge	S	S
Chip cart with coolant drain		O	O
Chuck air blow		O	O
Tailstock air blow		O	O
Oil mist collector		O	O
AUTOMATIC OPERATION SUPPORT			
Work-piece transport conveyor		O	O
Bar feeder & interface		O	O
Gantry-type loader / unloader		O	O
Auto door		O	O
External M-code output	4 sets (8)	O	O
	8 sets (16)	O	O

Specations are subject to change without notice.

*1 Not available on L³ series.

*2 Standard with tailstock option.

*3 10.4" color LCD option needed.

*4 The milling axis is servo motor which is available when equipped the with live tooling turret.

		GS-4000	GS-4300
SAFETY			
Fully enclosed guarding		S	S
Impact resistant viewing window		S	S
Tailstock stroke out - end check ^{*2}		S	S
Chuck cylinder stroke out - end check		S	S
Low hydraulic pressure detection switch		S	S
Load monitoring function		O	O
OTHERS			
Tri-color operation status light tower		S	S
External work light		O	O
Electrical cabinet	Heat exchanger	S	S
	A/C cooling system	O	O
Complete hydraulic system		S	S
Advanced auto lubrication system		S	S
Foundation leveling & maintenance tool kit		S	S
Emergency maintenance electrical part package		S	S
Operation & maintenance manuals		S	S

		Oi-TF	31i
FANUC CONTROL FUNCTIONS			
Display	8.4" color LCD	S	-
	10.4" color LCD	O	S
Graphic function	Standard	S	S
	Dynamic	O	O
Full keypad	Small - 44 keys	S	-
	Large - 56 keys	O ^{*3}	S
Part program storage length	512 K bytes	S	-
	1 M bytes	-	S
	2 M bytes	O	O
	4 M bytes	-	O
	8 M bytes	-	O
Registrable programs	400	S	-
	800	-	-
	1,000	O	S
	4,000	-	O
	99	-	S
Tool onset pairs	128	S	-
	200	O	-
	400	-	O
	499	-	O
	999	-	O
Servo control	2000	-	O
	HRV3	S	S
Conversational programming	Manual Guide Oi	S	-
	Manual Guide i	O ^{*3}	S
Servo motors	α i	S	S
Spindle motors	α i	S	S
Tool Life Management		S	S
Tool Nose Radius Compensation		S	S
DNC Transmission		S	O
Variable Lead Thread Cutting		S	S
Polygon Turning		S	S ^{*4}
Unexpected disturbance torque detection function		S	S
Polar coordinate & cylindrical interpolation		-	O
Multiple Threading		S	S
Run hour & parts counter		S	S
Auto power off function		S	S
RS-232 port		S	S
Memory card input/output		S	S
USB input/output		S	S
Ethernet		S	S

MACHINE SPECIFICATIONS

■ : Metric ■ : Inch

19
20

CAPACITY		GS-4000	GS-4300
Max. swing diameter		Ø 770 mm	30.3"
Swing over saddle		Ø 940 mm	37"
Max. turning diameter		Ø 620 mm	24.4"
Std. turning diameter		Ø 268 mm	10.5"
Max. turning length		819 / 1,569 / 2,369 / 3,169 mm [15" Chuck] ^{*1*2} 32.2" / 61.7" / 93.2" / 124.7"	
Chuck size		15" (18")	20" (24")
Bar capacity		Ø 115 mm 4.5"	Ø 165 mm 6.4"
SPINDLE			
Hole through draw tube		Ø 118 mm 4.6"	Ø 165.5 mm 6.5"
Hole through spindle		Ø 131 mm 5.1"	Ø 181 mm 7.1"
Spindle bearing diameter (Front / Rear)		Ø 180 / 160 mm 7" / 6.2"	Ø 240 / 220 mm 9.4" / 8.6"
Hydraulic cylinder		15" (18")	20" (24")
Spindle nose		A2-11	A2-15
Motor output (Cont. / 30 min.)		30 / 37 kW 40 / 50 HP	
Motor full output speed		1,150 rpm	
Motor full output speed		2-Speed Gear box	
Spindle drive system		1: 3 / 1: 6	1: 5 / 1: 10
Spindle speed ranges	L	10 ~ 1,000 rpm	6 ~ 600 rpm
	H	20 ~ 2,000 rpm	12 ~ 1,200 rpm
Spindle full output speed	L	196 rpm	121 rpm
	H	388 rpm	239 rpm
Spindle torque (Cont. / 30 min.)	L	1,463 / 1,805 N-m 1,079 / 1,331 lb-ft	2,370 / 2,923 N-m 1,748 / 2,156 lb-ft
Spindle torque (Cont. / 30 min.)	H	739 / 911 N-m 545 / 671 lb-ft	1,197 / 1,476 N-m 882 / 1,088 lb-ft
C-AXIS SPINDLE (OPTIONAL)			
Drive type		Cs	
Torque output		1,805 N-m 1,331 lb-ft	2,923 N-m 2,156 lb-ft
X & Z AXES			
Max. X-axis travel		350 mm 13.7"	
Max. Z-axis travel		850 / 1,600 / 2,400 / 3,200 mm ^{*2} 33.4" / 62.9" / 94.4" / 125.9" ^{*2}	
Max. Zs-axis travel		800 / 1,550 / — / — mm ^{*2} 31.4" / 61" / — / — ^{*2}	
X-axis rapids		24 m/min. 945 IPM	
Z-axis rapids		24 / 24 / 16 / 12 m/min. ^{*2} 944 / 944 / 629 / 472 IPM	
Zs-axis rapids		24 / 24 / — / — m/min. ^{*2} 944 / 944 / — / — IPM	
Slide way type		Hardened & Ground Box Ways	
Feed rates		1 ~ 4,800 mm/min. 1 ~ 189 IPM	
X-axis servo motor		7 kW 9 HP	
Z-axis servo motor		7 kW 9 HP	
Zs-axis servo motor		3 kW 4 HP	
X-axis ball screw Ø pitch		Ø 36 mm [10 mm] 1.4" [0.39"]	
Z-axis ball screw Ø pitch		Ø 45 mm [10 mm] / Ø 45 mm [10 mm] / Ø 63 mm [16 mm] / Ø 63 mm [16 mm] ^{*2} Ø 1.7" [0.39"] / Ø 1.7" [0.39"] / Ø 2.4" [0.62"] / Ø 2.4" [0.62"] ^{*2}	
Zs-axis ball screw Ø pitch		Ø 36 mm [10 mm] / Ø 40 mm [10 mm] / — / — ^{*2} Ø 1.4" [0.39"] / Ø 1.5" [0.39"] / — / — ^{*2}	
X-axis thrust (Cont.)		1,921 Kg ^f 4,235 lbf	
Z-axis thrust (Cont.)		1,921 / 1,921 / 1,801 / 1,801 Kg ^{f*2} 4,235 / 4,235 / 3,970 / 3,970 lbf ^{*2}	
Zs-axis thrust (Cont.)		769 / 769 / — / — Kg ^{f*2} 1,695 / 1,695 / — / — lbf ^{*2}	

Specifications are subject to change without notice.

*1 Individual models may vary, detail specification please see work range diagram or contact with Goodway.

*2 GS-4000 / 4000L / 4000L² / 4000L³

MACHINE SPECIFICATIONS

TURRET	GS-4000	GS-4300
Stations	12 (Opt. 10)	
Indexing speed	0.3 sec. Adjacent / 0.8 sec. (Single step)	
Accuracy	Positioning : ± 0.00069°, Repeatability : ± 0.00027°	
OD tool shank size	□ 32 mm 1-1/4"	
ID tool shank size	Ø 60 mm 2-1/2"	
LIVE TOOLING TURRET (OPTIONAL)		
Max. turning diameter	Ø 550 mm 21.6"	
Std. turning diameter	Ø 305 mm 12"	
Max. turning length	695 / 1,445 / 2,245 / 3,045 mm [15" Chuck] ^{*1*2} 27.3" / 56.8" / 88.3" / 119.8" [15" Chuck] ^{*1*2}	
Stations	12	
Live tooling stations	12	
Live tooling drive motor (Cont. / 30 min.)	5.5 / 7.5 kW (decelerate 1 : 2) [Y-axis : 3.7 / 5.5 kW built-in motor]	
Index speed	0.3 sec. Adjacent / 0.8 sec. (Single step)	
OD tool shank size	□ 25 mm 1"	
ID tool shank size	Ø 50 mm 2"	
Live tooling shank size	ER 40	
Live tooling RPM range	4,000 rpm [Y-axis : 6,000 rpm]	
Y-AXIS (OPTIONAL)		
Max. swing diameter	Ø 700 mm 27.5"	
Swing over saddle	Ø 900 mm 35.4"	
Max. turning diameter	Ø 460 mm 18.1"	
Max. turning length	695 / 1,445 / 2,245 / 3,045 mm [15" Chuck] ^{*2} 27.3" / 56.8" / 88.3" / 119.8" [15" Chuck] ^{*2}	
Max. X-axis travel	300 mm 11.8"	
Max. Y-axis travel	120 mm = ± 60 mm 4.7" = ± 2.3"	
X / Y axes rapids	24 / 10 m/min. 944 / 393 IPM	
Slide way type	Hardened & Ground Box Ways	
Feed rates	1 ~ 4,800 mm/min. 1 ~ 189 IPM	
X-axis servo motor	7 kW 9 HP	
Y-axis servo motor	4 kW 5 HP	
X-axis ball screw Ø / pitch	Ø 36 mm / 10 mm 1.4" / 0.39"	
Y-axis ball screw Ø / pitch	Ø 36 mm / 8 mm 1.4" / 0.31"	
X / Y axes thrust (Cont.)	1,921 / 1,761 Kgf 4,235 / 3,882 lbf	
TAILSTOCK		
Quill center taper	MT#4 (Built-in type dead center , Servo tailstock) ^{*3} MT#5 (Live center , Servo tailstock) ^{*3} MT#6 (Live center , Programmable tailstock)	
Quill diameter	MT#4 : Ø 110 mm 4.3" / MT#5 : — / MT#6 : Ø 120 mm 4.7"	
Quill travel	MT#4 : — / MT#5 : — / MT#6 : 150 mm 5.9"	
Tailstock base travel	GS-4000 : 800 mm 31.5" (Servo tailstock) / 650 mm 25.6" (Quill programmable tailstock) ^{*3} GS-4000L ² : 1,550 mm 61" (Servo tailstock) / 1,400 mm 55.1" (Quill programmable tailstock) ^{*3} GS-4000L ² : 2,200 mm 86.6" (Quill programmable tailstock) GS-4000L ³ : 3,000 mm 118.1" (Quill programmable tailstock)	
Programmable quill / base	MT#4 : — / Yes / MT#5 : — / Yes / MT#6 : Yes / Yes	

Specifications are subject to change without notice.

*1 Individual models may vary, detail specification please see work range diagram or contact with Goodway

*2 GS-4000 / 4000L / 4000L² / 4000L³

*3 Option

SUB-SPINDLE (OPTIONAL) ^{*4}	GS-4000	GS-4300
Chuck size	8"	
Hole through spindle	Ø 55 mm 2.16"	
Spindle bearing diameter	Front : Ø 100 mm 3.93" / Rear : Ø 70 mm 2.75"	
Spindle nose	A2-6	
Motor output (Cont.)	15 kW 20 HP	
Motor output (15 min.)	18.5 kW 24.8 HP	
Motor full output speed	5,000 rpm	
Spindle drive system	Direct built-in motor (Integrated Motor)	
Spindle drive ratio	1 : 1	
Spindle speed range	4,800 rpm	
Spindle torque (Cont.)	95 N-m 70 lb-ft	
Spindle torque (15 min.)	118 N-m 87 lb-ft	
Zs-axis travel	800 / 1,550 / — / — mm 31.5" / 61" / — / —	
Zs-axis rapid	24 / 24 / — / — m/min. 944 / 944 / — / — IPM	
Slide way type	Hardened & Ground Box Ways	
Zs-axis servo motor	3.0 kW 4 HP	
Zs-axis ball screw Ø [pitch]	Ø 36 mm [10 mm] / Ø 40 mm [10 mm] / — / — ^{*2} Ø 1.4" [0.39"] / Ø 1.5" [0.39"] / — / — ^{*2}	
Zs-axis thrust (Cont.)	769 / 769 / — / — Kgf 1,692 / 1,692 / — / — lbf	
ACCURACY / GENERAL		
Positioning accuracy	± 0.005 mm ± 0.0002"	
Repeatability	± 0.003 mm ± 0.0001"	
Standard CNC control	FANUC Oi-TF (31i Opt.)	
Voltage / Power requirement	AC 200/220 + 10% to - 15% 3 phase / 65 KVA	
Hydraulic tank capacity	45 L 11 gal	
Coolant tank capacity	330 / 410 / 540 / 670 L ^{*2} 87 / 108 / 142 / 176 gal ^{*2}	
Coolant pump	0.7 kW 0.93 HP (60 Hz) rated at 3 bar (44 PSI)	
Machine weight	8,000 / 11,000 / 13,500 / 16,000 Kg ^{*2} 17,700 / 24,300 / 29,800 / 35,300 lb ^{*2}	
Dimensions L × W × H	4,020 × 2,260 × 2,120 mm 159" × 89" × 84"	
	L : 4,700 × 2,480 × 2,120 mm 186" × 98" × 84"	
	L ² : 5,640 × 2,570 × 2,120 mm 223" × 102" × 84"	
	L ³ : 6,440 × 2,570 × 2,120 mm 254" × 102" × 84"	

Specifications are subject to change without notice.

*4 Not available on L² and L³ series.

Machine Dimensions

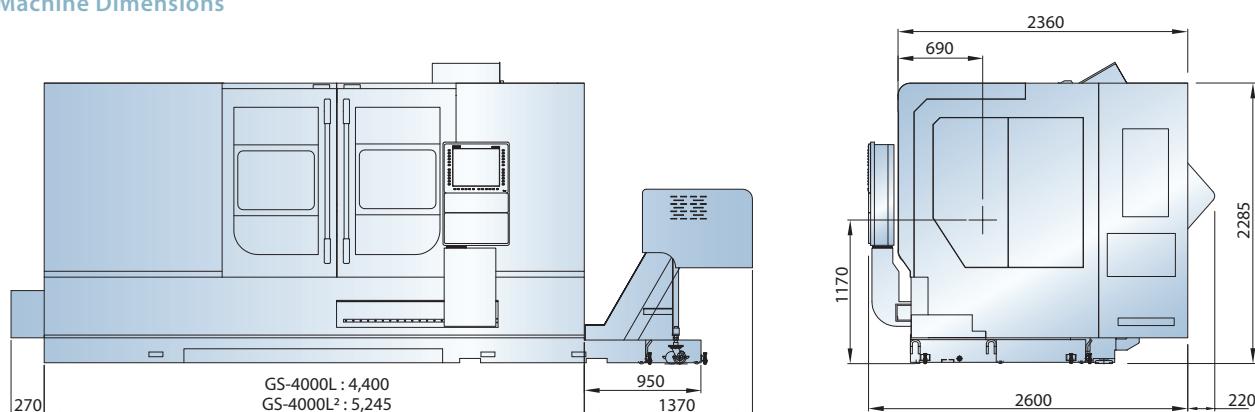

Unit : mm



GOODWAYCNC.com

GOODWAY MACHINE CORP.

HEADQUARTERS

No.13, 5th Road,
Taichung Industrial Park,
Taichung City, 407, Taiwan
E-mail : goodway@goodwaycnc.com

CENTRAL TAIWAN SCIENCE PARK BRANCH

No. 38, Keyuan Road,
Central Taiwan Science Park.Taichung,
Taichung City, 407, Taiwan
TEL : + 886-4-2463-6000
FAX : + 886-4-2463-9600

GOODWAY MACHINE (WUJIANG) CO.,LTD

No. 4888, East Lake Taihu Avenue, Wujiang
Economic and Technological Development Zone,
Jiangsu, China
Sales Hotline : + 86-512-8286-8068
Service Hotline : + 86-512-8286-8066
FAX : + 86-512-8286-8620
E-mail : goodway@goodwaycnc.cn